

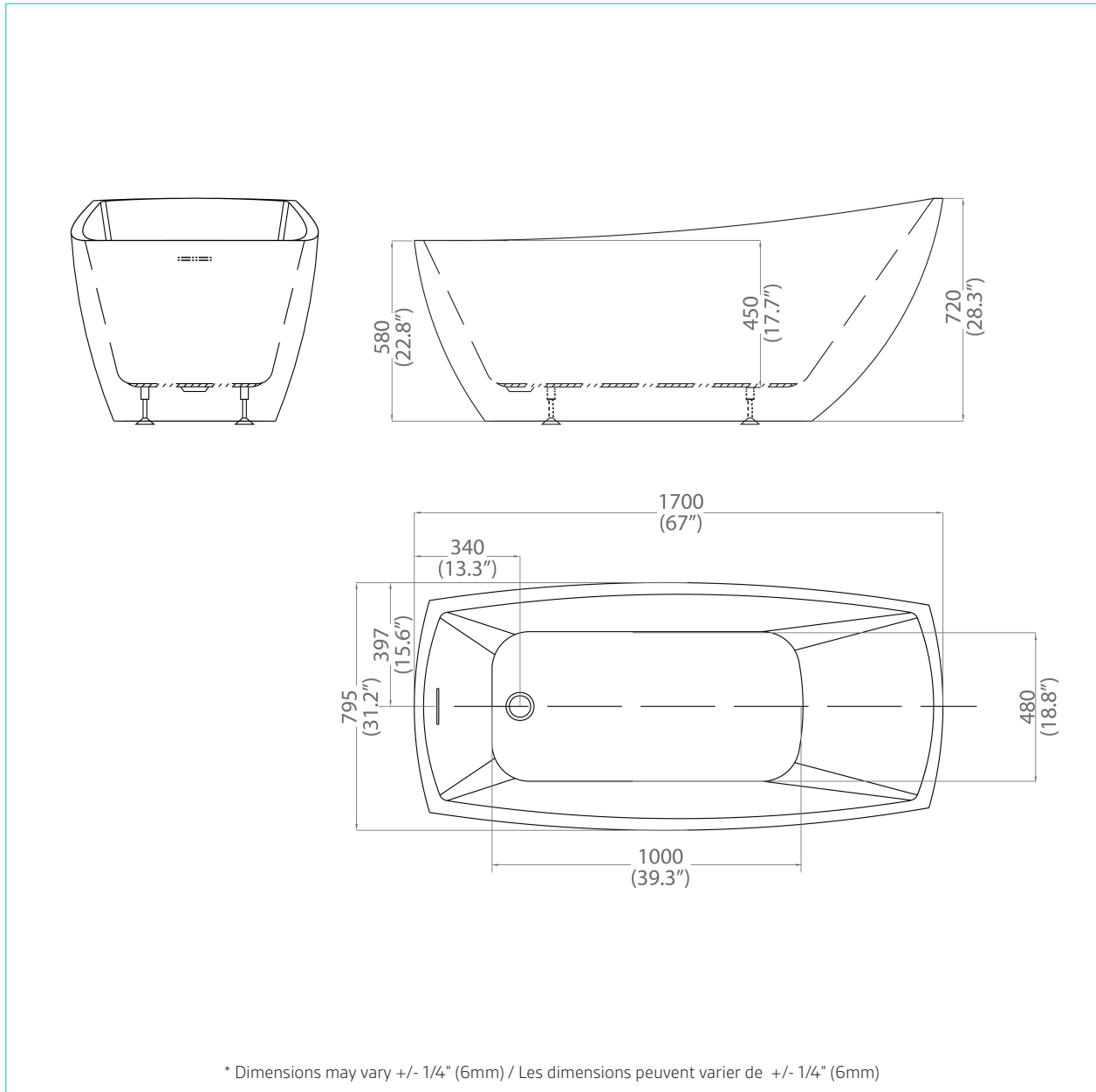

**FREESTANDING
BATHTUBS**

**BAIGNOIRES
AUTOPORTANTES**

BT-944-67-BLK



DIMENSIONS		WEIGHT POIDS		MATERIAL MATERIEL		OVERFLOW HEIGHT HAUTEUR DU TROP-PLEIN		WATER CAPACITY CAPACITÉ DE L'EAU	
67 x 31.2 x 28.3" 1700 x 795 x 720 mm		103.6 lbs 47 Kg		Acrylic Acrylique		14.7" 375mm		68.7 gal 2360 lts	
FINISH FINITION		DRAIN LOCATION LOCATION DU DRAIN		PIECES PIÈCES		COMPLIANCE CERTIFICATIONS: Uniform Plumbing Code National Plumbing Code of Canada CSA B45.5-17/IAPMO Z124-2017			
Matte Mate		End Coin		1 pc					



**FREESTANDING
BATHTUBS**

**BAIGNOIRES
AUTOPORTANTES**

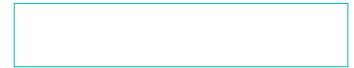

Pure acrylic construction reinforced by fiberglass
Construction en acrylique renforcée de fibre de verre

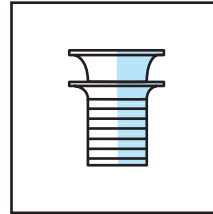

Pop-up drain included
Drain pop-up inclus

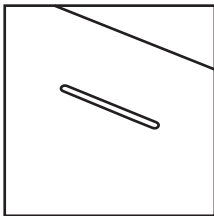

Linear overflow
Trop plein linéaire

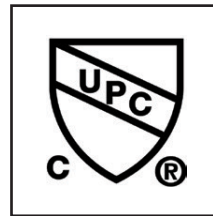

cUPC Certified
Certifié cUPC

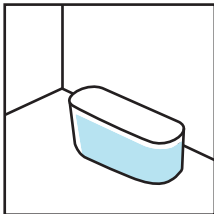

Freestanding installation
Installation autoportante

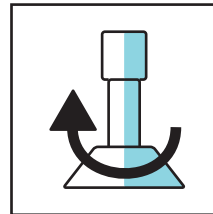

Adjustable feet
Pieds ajustables